

PROJECT-OUT WINDOWS

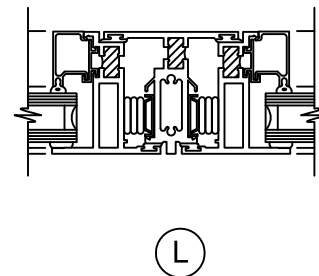

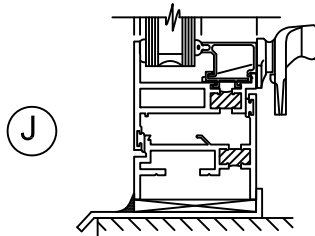
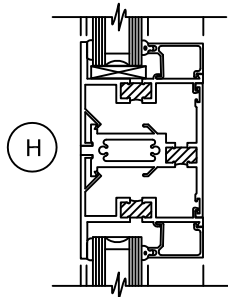
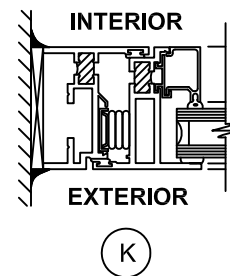
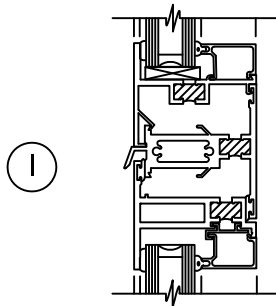
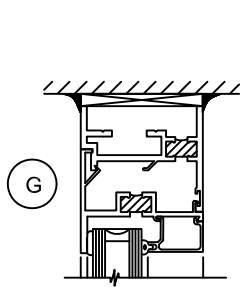
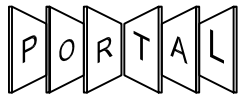

PROJECT-OUT WINDOWS

G
HEAD / JAMB

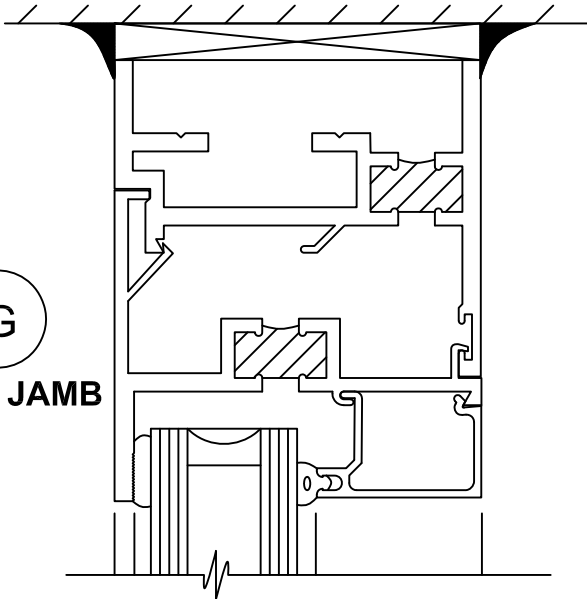

I
HORIZONTAL
AT SASH

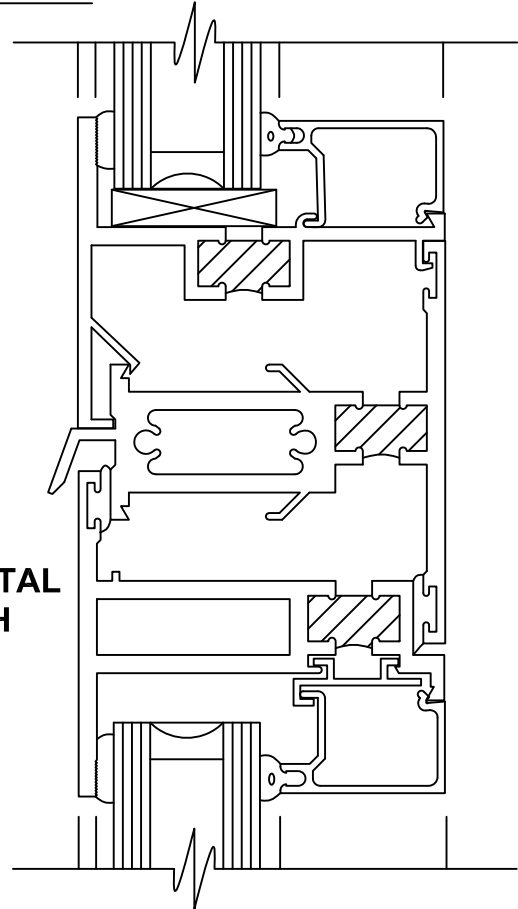

H
HORIZONTAL
(VERTICAL)
MULLION

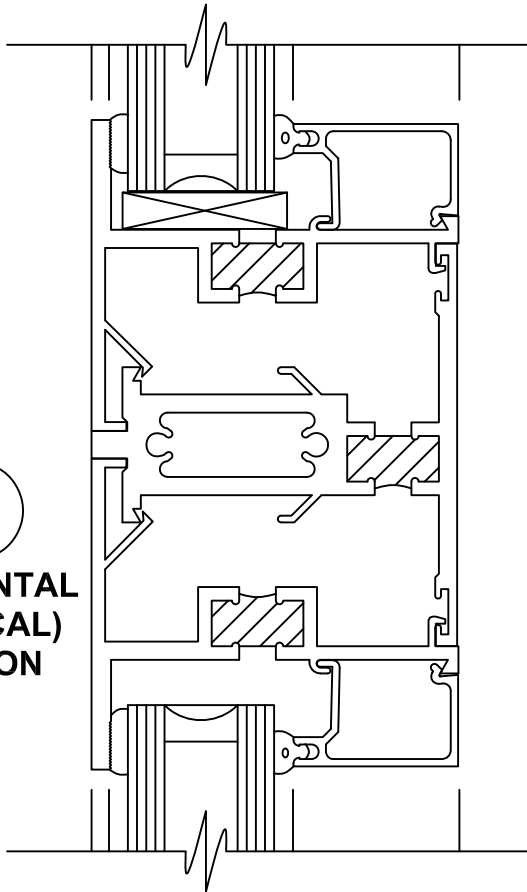

D
SILL AT SASH

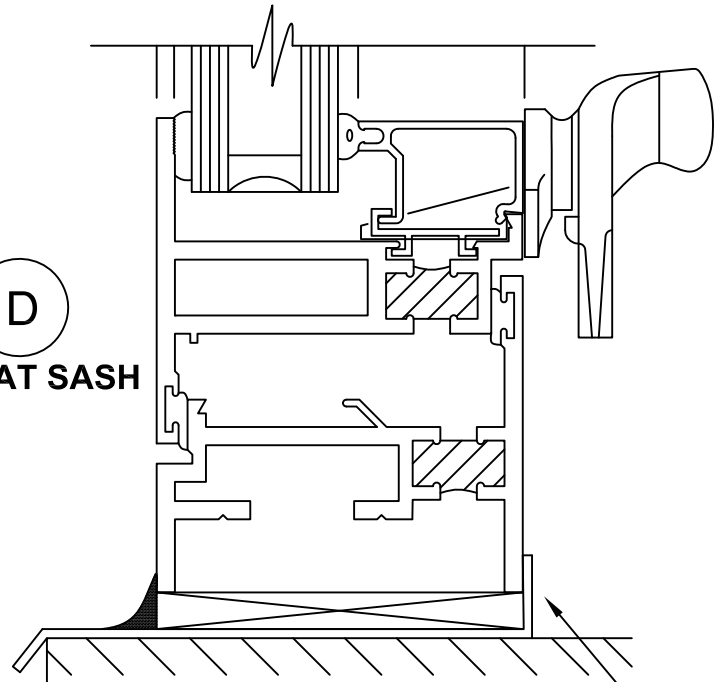

RECOMMENDED SILL FLASHING.

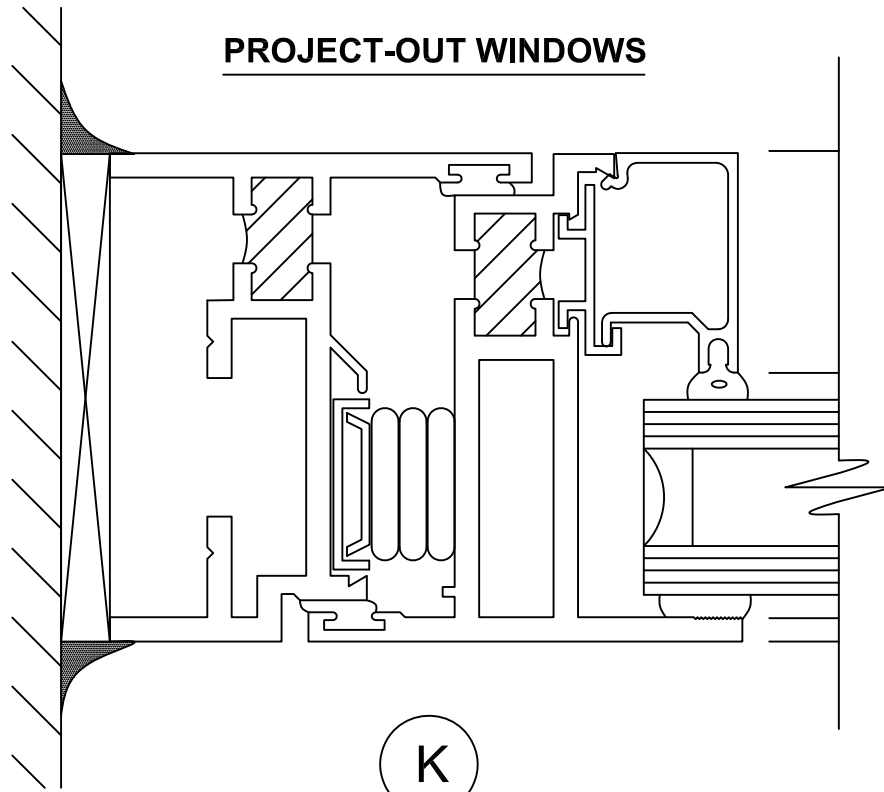
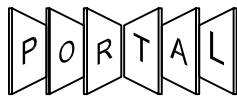

JAMB AT SASH

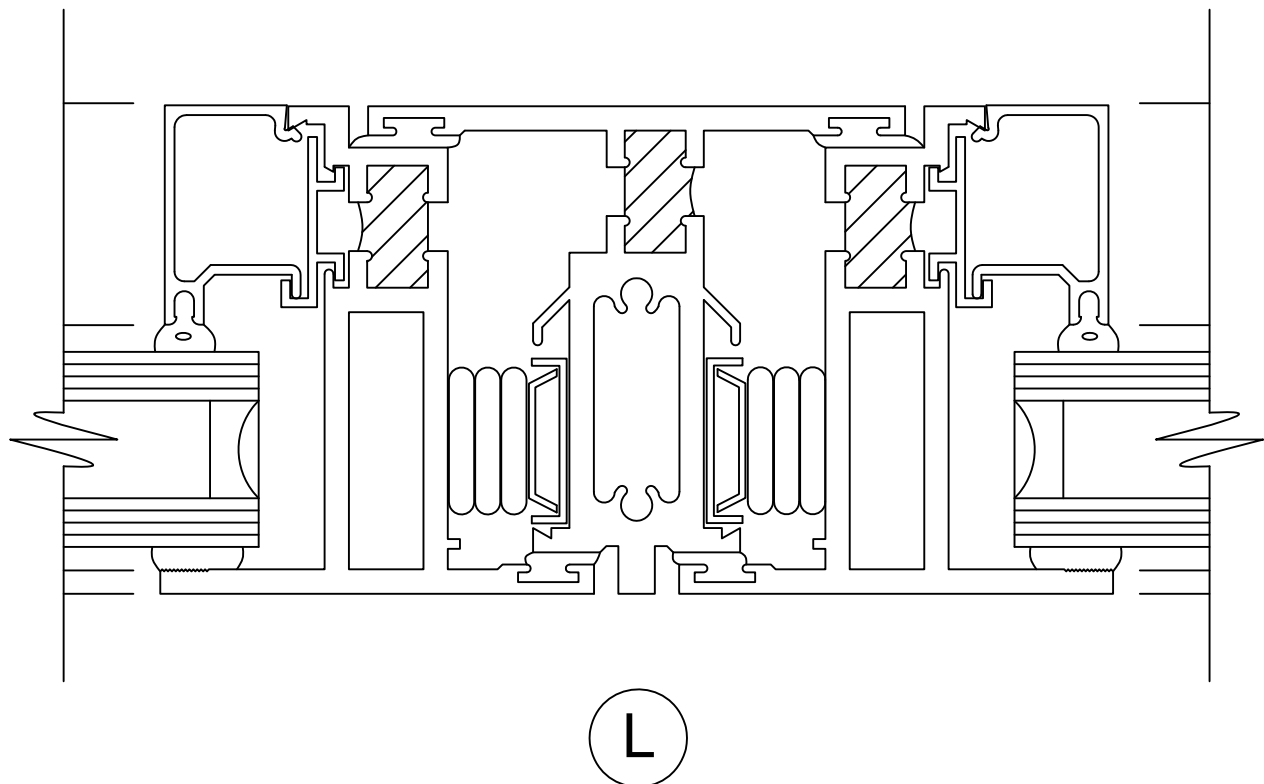

VERTICAL MULLION BETWEEN SASHES